

FOX BARNS

MODULAR BARNS, SHELTERS & FENCING SOLUTIONS



Fox Barns was founded in 2015 when our horse rescue, Fox Equine Rescue & Youth Horsemanship Center, moved and needed fencing and shelters for our 15 rescue horses. We couldn't find what we needed at an affordable price, so we started to manufacture and sell livestock shelters, breezeway & shed row barns, corral/fencing panels, round pens, and gates.

The shelters are all modular and clamp together, the roofing attaches with self tapping screws, all included. You can customize the shelters, add gates, runs/paddocks, plywood ready walls, and add more shelters in a row sharing walls to make shed-row style barns. We also offer a line of breezeway style barns with a 12' wide covered center isle, in both 4 rail and plywood-ready walls.

All of the steel tubing for our shelters and standard panels/round pens is heavy, 16 gauge galvanized 1-5/8" tubing with welds 360 degree around so they won't rust or bend easily like other cheaper, thinner panels. All shelters are 8 feet on the front and slope to 7 feet in the back and include the roof and 3 sides, gates optional.

In addition to the shelters & barns we also offer a line of fencing panels & round pens in both heavy duty and a lighter weight 19 gauge portable 12-foot 4 rail panels with pins instead of clamps.

Contents

» 4 Rail, 3-SIDED SHELTER, SHED ROW BARN	Page. 1
Single Stall	Page. 2
2, 3, 4, 5 Stalls.....	Page. 3
» Plywood Ready, 3-SIDED SHELTER, SHED ROW BARN	Page. 4
Single Stall	Page. 5
2, 3, 4, 5 Stalls.....	Page. 6
» 4 Rail, BREEZEWAY, BARN	Page. 7
2 Stalls.....	Page. 8
4 Stalls.....	Page. 9
6 Stalls.....	Page. 10
8 Stalls	Page. 11
» Plywood Ready BARN	Page. 12
2 Stalls	Page. 13
4 Stalls.....	Page. 14
6 Stalls.....	Page. 15
8 Stalls.....	Page. 16
» SHELTER OPTIONS	Page. 17

**4 RAIL,
3-SIDED SHELTER**

12x12 shelter including clamps and self tapping roof screws. Shelters are 8' tall front sloping to 7' tall rear, 4 rail walls on 3 sides with open front.

**4 RAIL,
SHED ROW BARN**

12x24 2 stall shelter with gate including clamps & self-tapping roof screws. Shelters have an 8' tall 4 rail gate front sloping to 7' tall rear with 4 rail walls, sharing divider wall.



**4 Rail
3-SIDED SHELTER
and
SHED ROW BARN**

*Starting at
\$1,100 per Stall*

Wind Anchors

7', 1-5/8" Galvanized
Steel Pole With Clamps
at \$50 each

**Paddocks/
Runs**

5' Tall x 12' Wide
4 Rail Panel
at \$180 each

Bow Gate

8' Tall x 12' Wide
6' Gate Inside
at \$350 each

**Plywood Ready
Walls**

7' Tall x 12' Wide Wall
(Plywood & Hardware Extra)
starting at \$50

SINGLE STALL

1 Stall, 4 Rail, 3 Sided Shelter

- » Stall Size = 12' x 12'
- » Total Cover Area = 12' x 12'
- » Starting at = **\$1,100** per stall

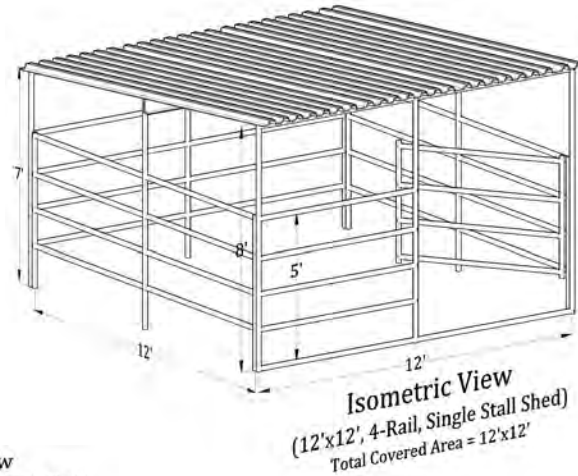
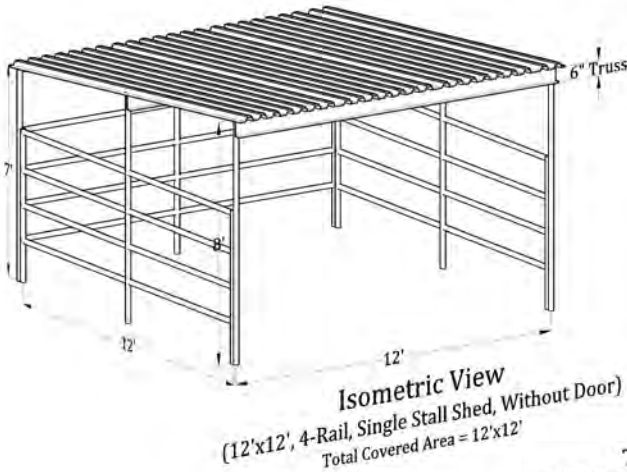
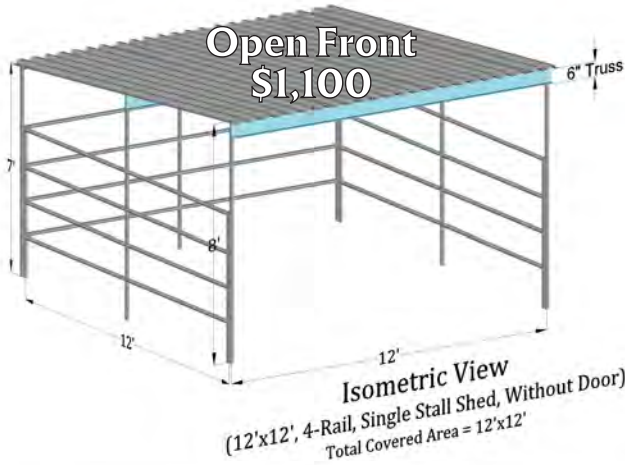

Side View
(12'x12', 4-Rail, Single Stall Shed)

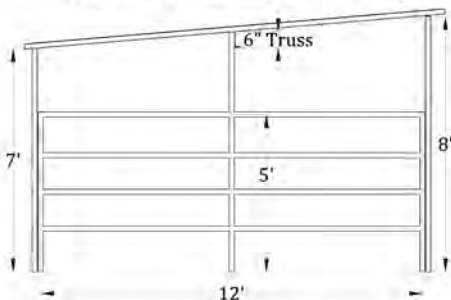

Front Elevation
(12'x12', 4-Rail, Single Stall Shed)

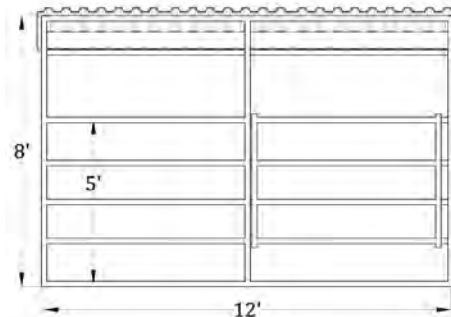

SHED ROW BARNS

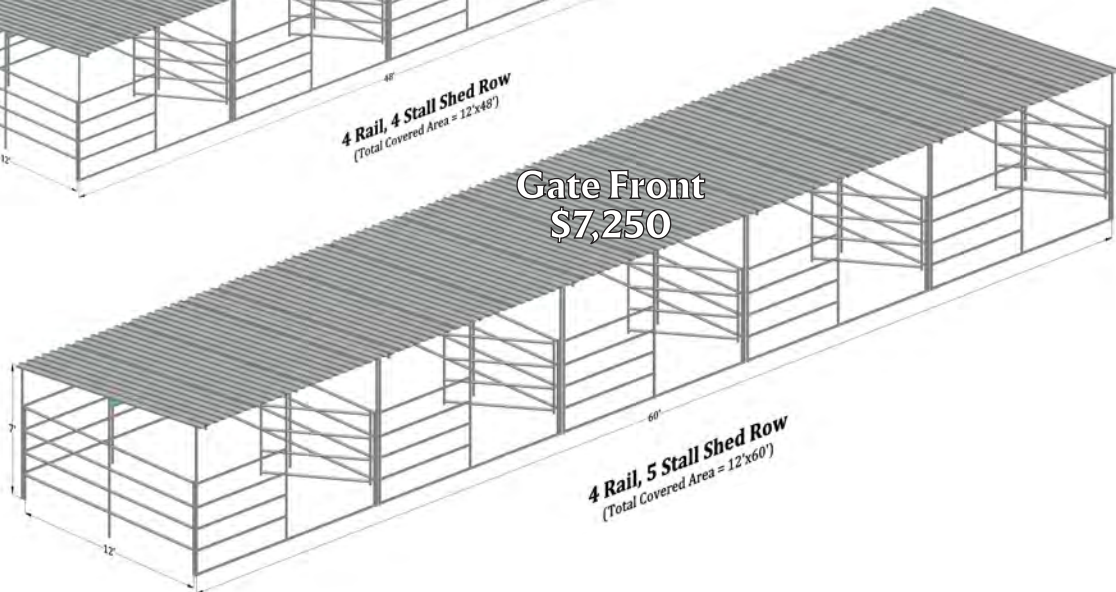
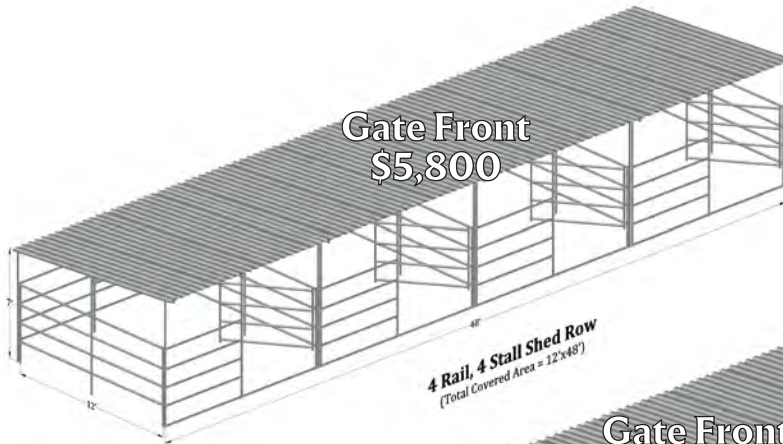
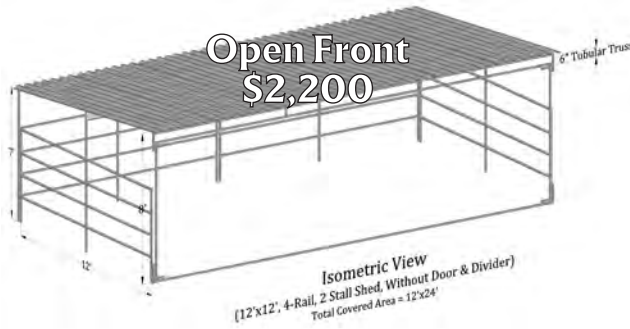

**PLYWOOD READY,
3-SIDED SHELTER**

12×12 shelter including clamps and self tapping roof screws. Shelters are 8' tall front sloping to 7' tall rear, plywood ready walls on 3 sides with open front.

**PLYWOOD READY,
SHED ROW BARN**

12×24 2 stall shelter with gate including clamps & self-tapping roof screws. Shelters have an 8' tall 4 rail gate front sloping to 7' tall rear with Plywood ready walls, sharing divider wall.



**Plywood Ready
3-SIDED SHELTER
and
SHED ROW BARN**

*Starting at
\$1,250 per Stall*

Wind Anchors

7', 1-5/8" Galvanized
Steel Pole With Clamps
at \$50 each

**Paddocks/
Runs**

5' Tall x 12' Wide
4 Rail Panel
at \$180 each

Bow Gate

8' Tall x 12' Wide
6' Gate Inside
at \$350 each

**Plywood & Mounting
Hardware**

3 sheets of 5/8 plywood
& mounting hardware,
per 12' wall \$450

SINGLE STALL

Plywood Ready, 3 Sided Shelter

- » Stall Size = 12' x 12'
- » Total Cover Area = 12' x 12'
- » Starting at = **\$1,250** per stall

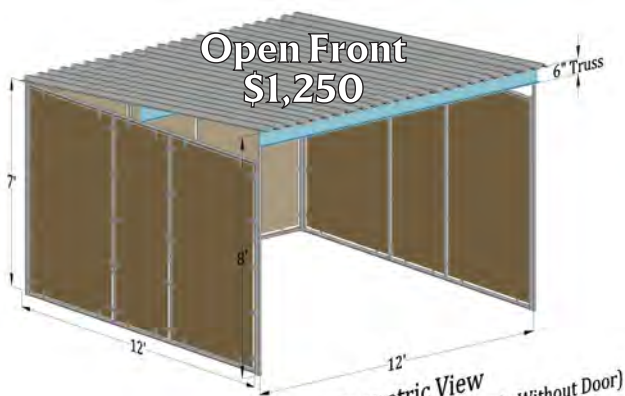

Open Front
\$1,250

Isometric View
(12'x12', Single Stall, Plywood Ready Shed - Without Door)
Total Area Covered = 12'x12'

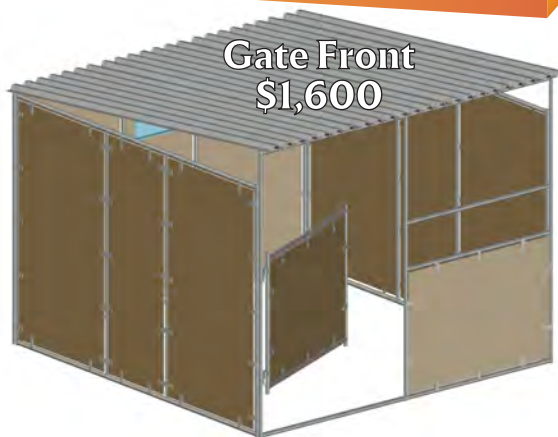

Gate Front
\$1,600

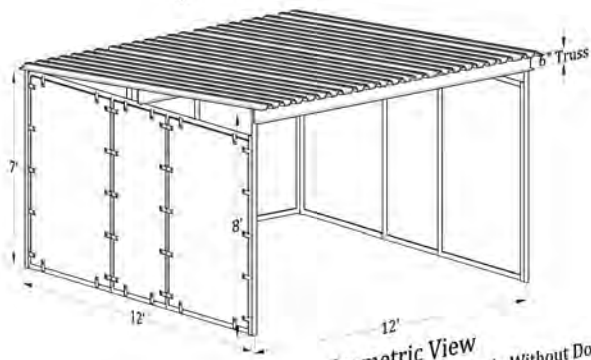

Isometric View
(12'x12', Single Stall, Plywood Ready Shed - Without Door)
Total Area Covered = 12'x12'

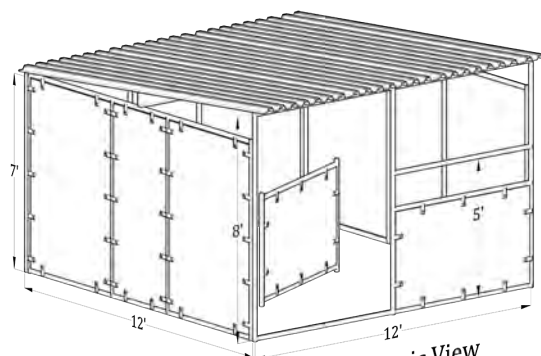

Isometric View
(12'x12', Single Stall, Plywood Ready Shed)
Total Area Covered = 12'x12'

Top View
(12'x12', Single Stall, Plywood Ready Shed)
Total Covered Area = 12'x12'

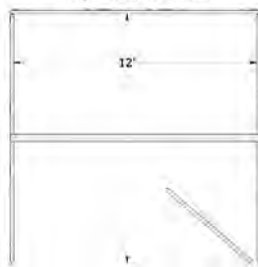

Side View
(12'x12', Single Stall, Plywood Ready Shed)

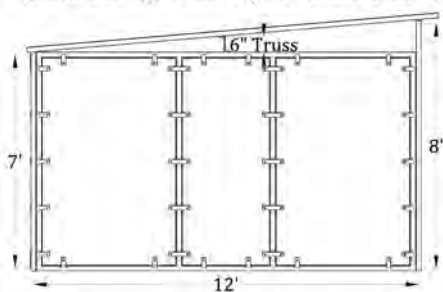

Front Elevation
(12'x12', Single Stall, Plywood Ready Shed)

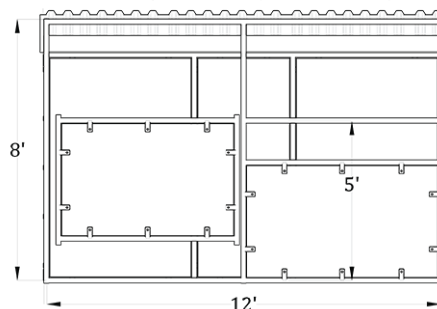

SHED ROW BARNs

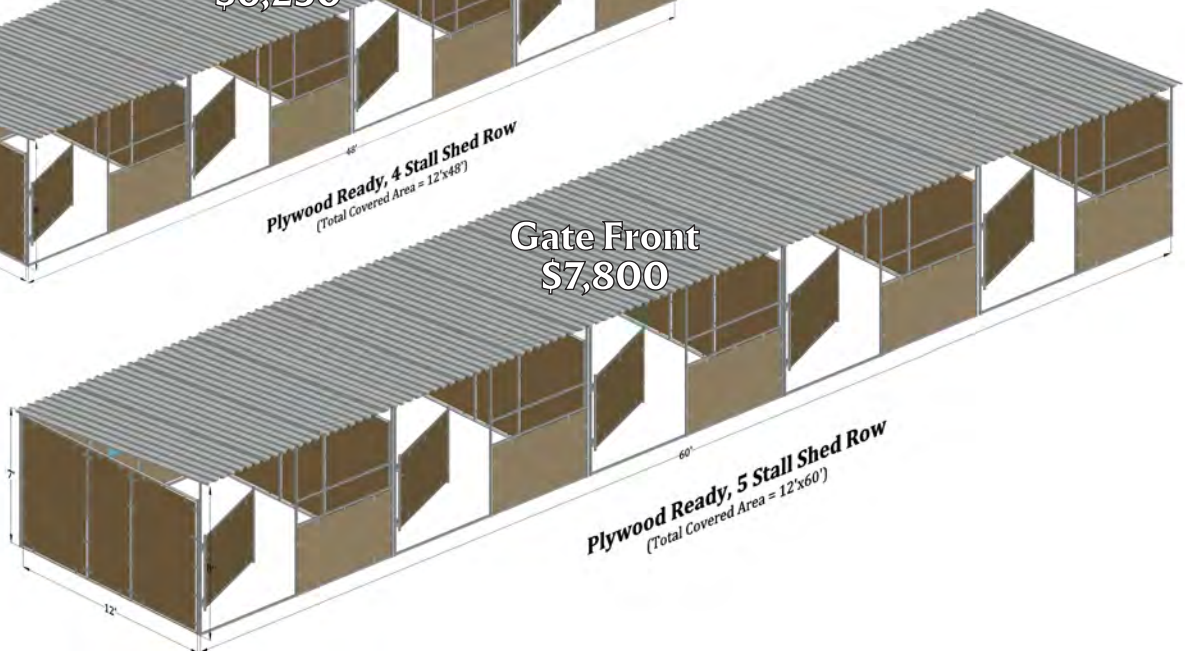
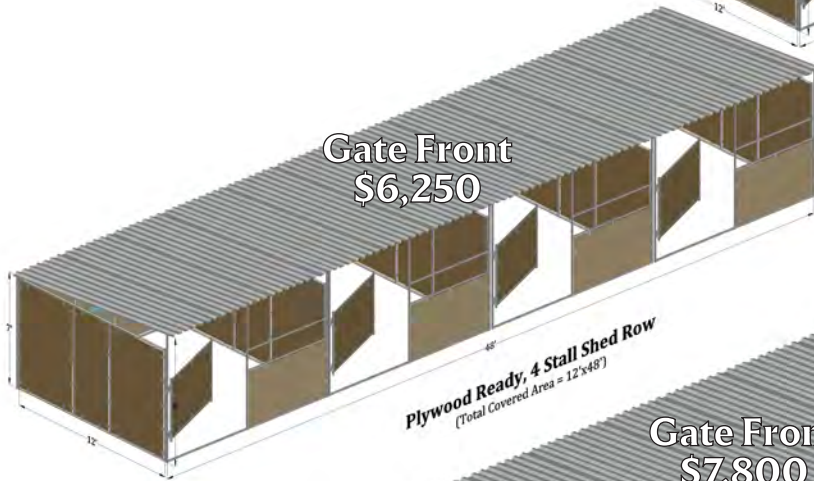
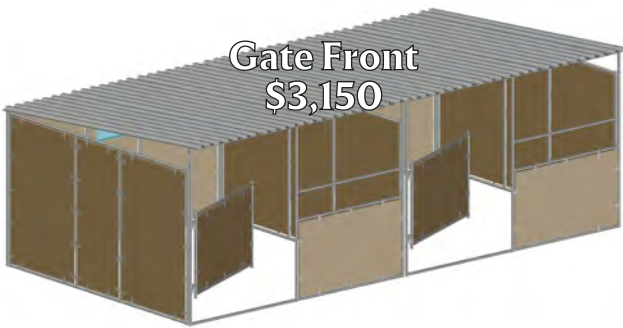
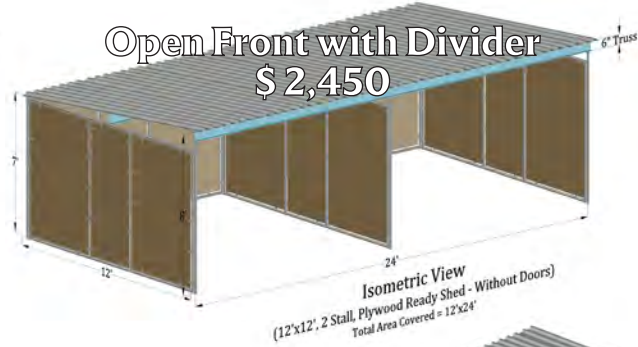

BREEZEWAY BARNS WITH COVERED AISLE

12'x12' stalls with 12' wide covered center aisle, including clamps & self tapping roof screws.

Shelters have an 8' tall gate front, sloping to 7' tall rear, 4 rail walls on 3 sides with 4 rail gate front, breezeway is 8.5' at center.

All of the steel tubing is heavy 16 gauge galvanized 1-5/8" tubing with welds 360 degree around so they won't rust or bend easily like other cheaper thinner panels. Barns & shelters are completely modular so you can always add onto them with additional 12x12 stalls or tack / grain / hay rooms.



4 Rail BREEZEWAY BARN

*Starting at
\$3,400*

Wind Anchors

7', 1-5/8" Galvanized
Steel Pole With Clamps
at \$50 each

Paddocks/ Runs

5' Tall x 12' Wide
4 Rail Panel
at \$180 each

Plywood Ready Walls

7' Tall x 12' Wide Wall
(Plywood & Hardware Extra)
starting at \$50

2 STALLS

2 Stall, 4 Rail Breezeway Barn

- » Stall Size = 12' x 12'
- » Total Cover Area = 12' x 36'
- » Starting at = \$3,400

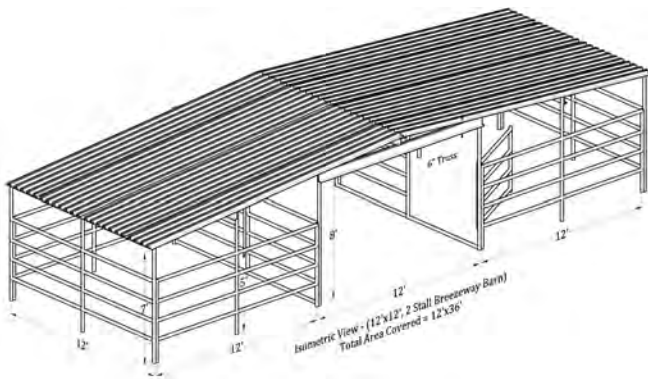
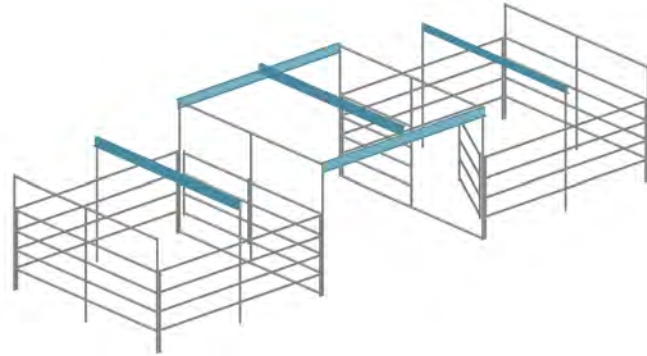

Side View (12'x12', 2 Stall Breezeway Barn)

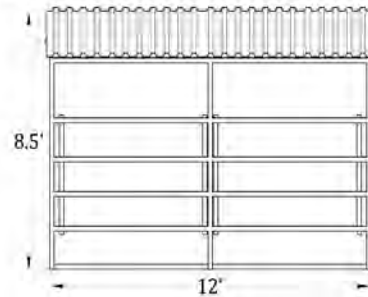

Front Elevation (12'x12', 2 Stall Breezeway Barn)

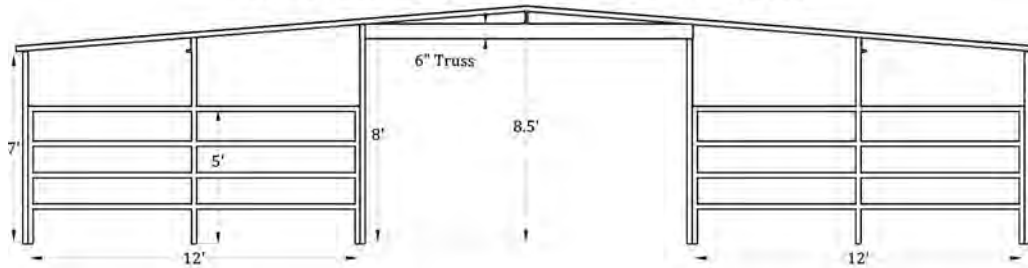

Top View (12'x12', 2 Stall Breezeway Barn)
Total Area Covered = 12'x36'

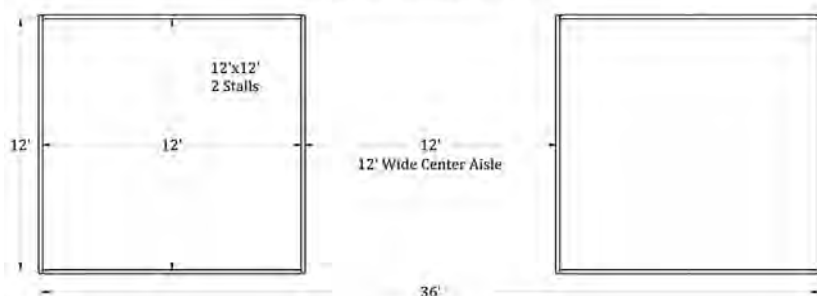

4 STALLS

4 Stall, 4 Rail Breezeway Barn

- » Stall Size = 12' x 12'
- » Total Cover Area = 24' x 36'
- » Starting at = \$6,800

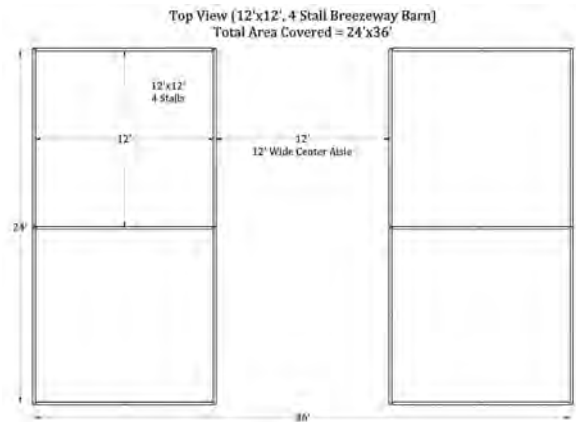
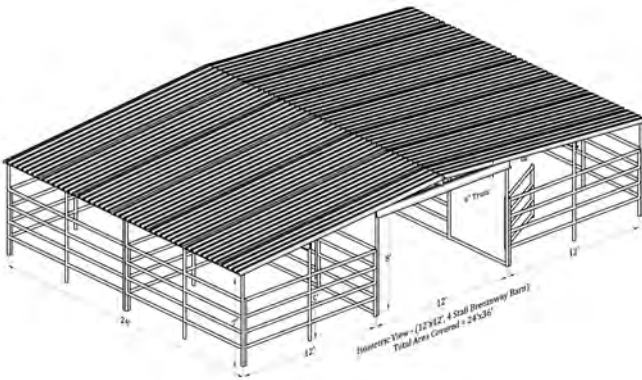
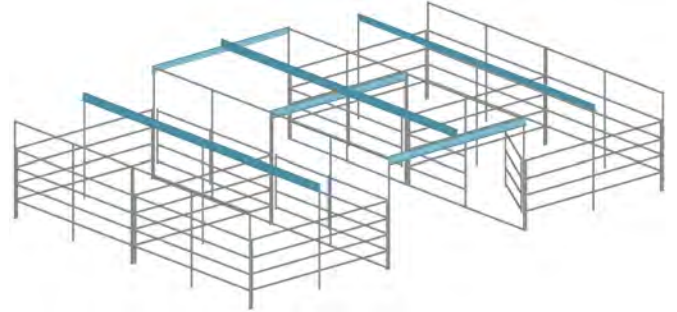
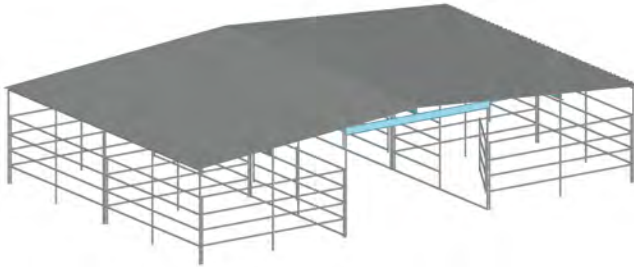

Front Elevation (12'x12', 4 Stall Breezeway Barn)

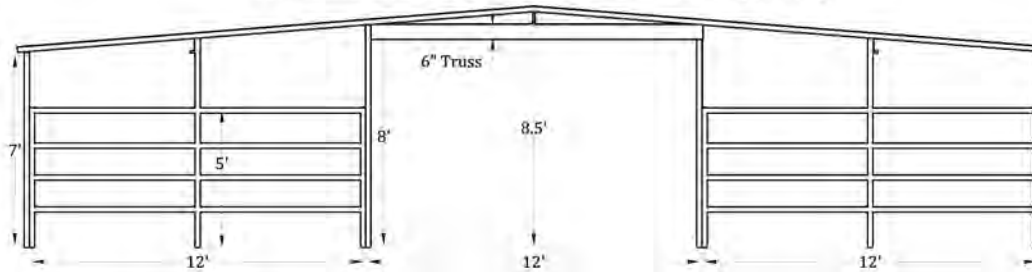

Side View (12'x12', 4 Stall Breezeway Barn)

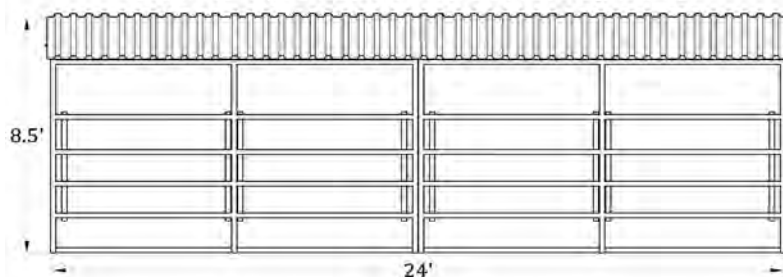

6 STALLS

6 Stall, 4 Rail Breezeway Barn

- » Stall Size = 12' x 12'
- » Total Cover Area = 36' x 36'
- » Starting at = \$10,200

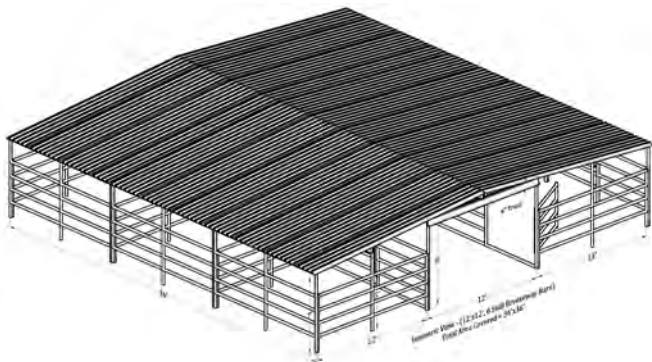
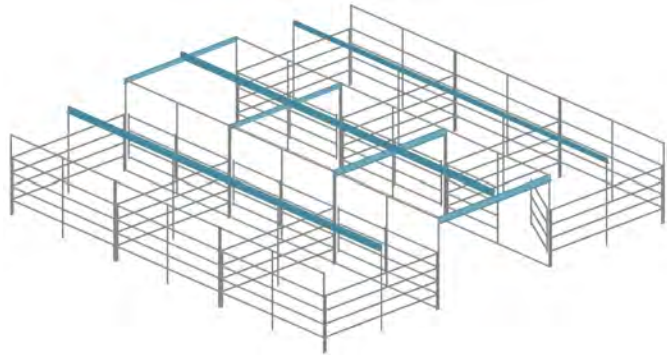
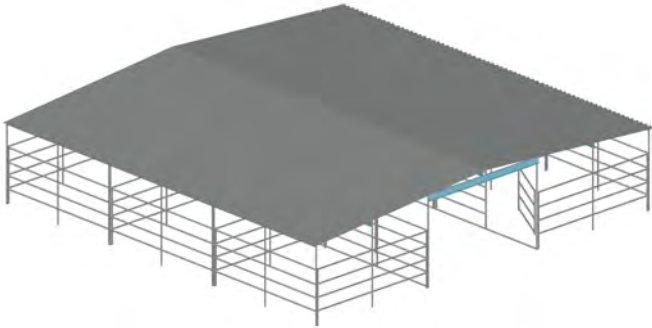

Top View (12'x12', 6 Stall Breezeway Barn)
Total Area Covered = 36'x36'

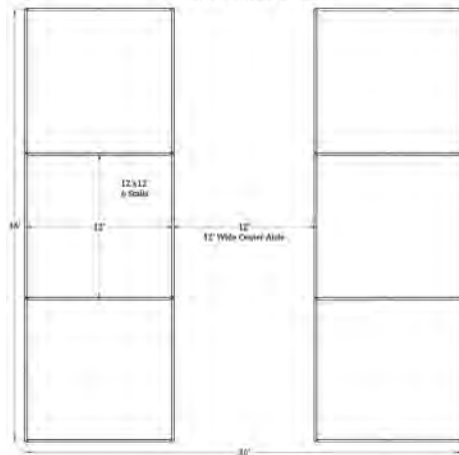

Front Elevation (12'x12', 6 Stall Breezeway Barn)

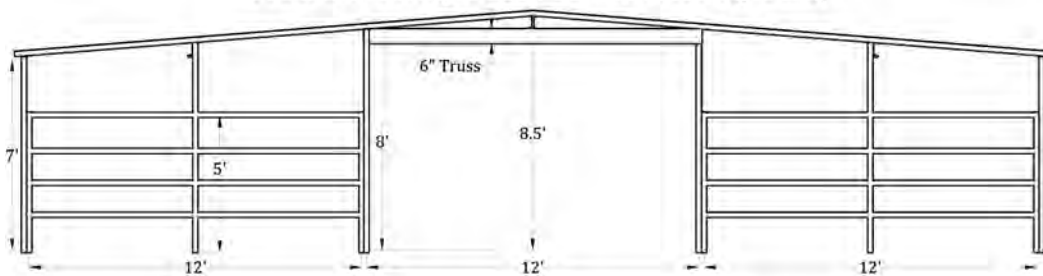

Side View (12'x12', 6 Stall Breezeway Barn)

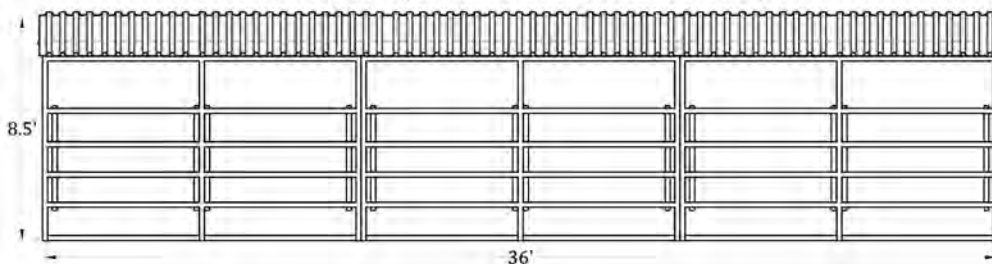

8 STALLS

8 Stall, 4 Rail Breezeway Barn

- » Stall Size = 12' x 12'
- » Total Cover Area = 48' x 36'
- » Starting at = \$13,600

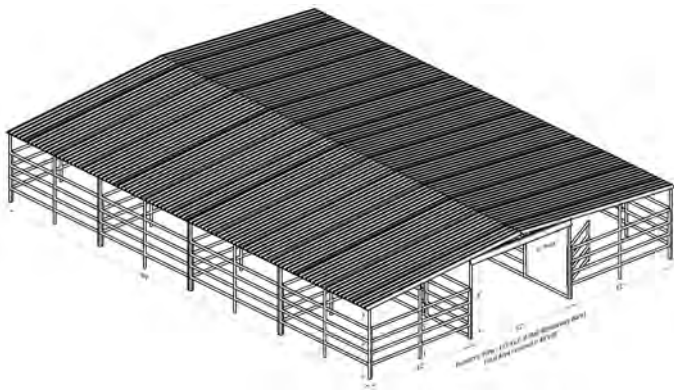
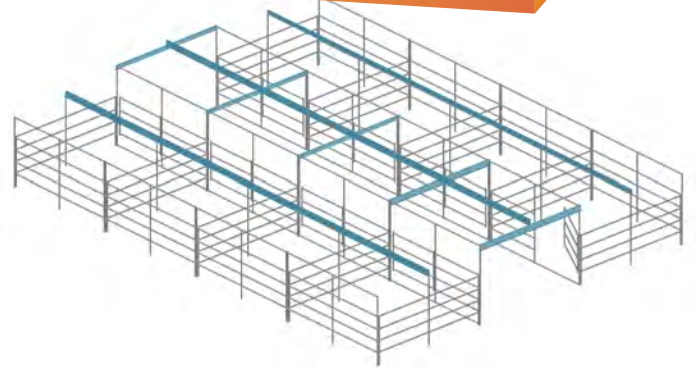

Front Elevation (12'x12', 8 Stall Breezeway Barn)

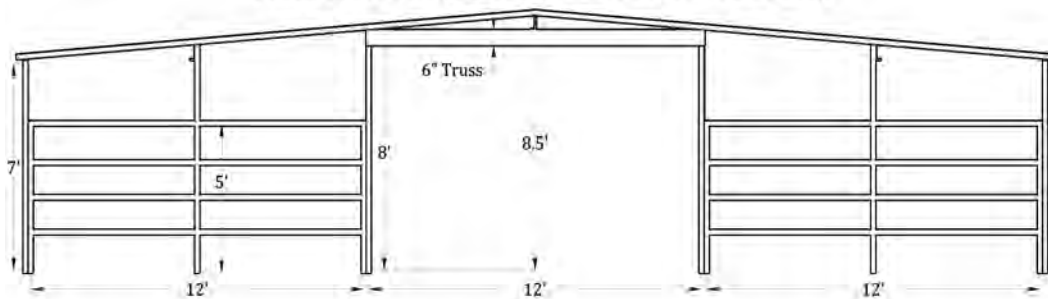

Side View (12'x12', 8 Stall Breezeway Barn)

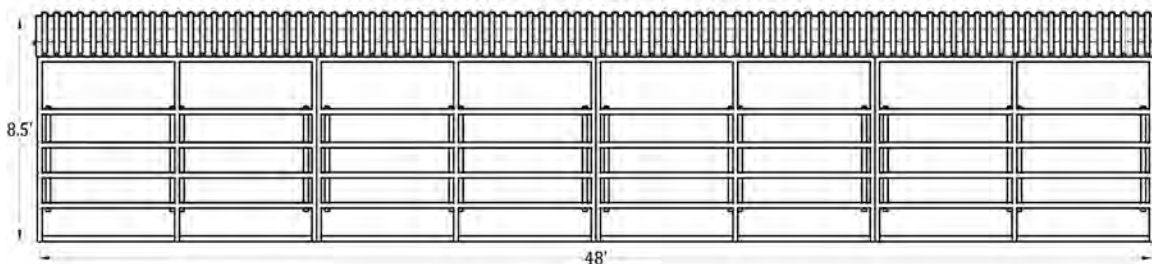

PLYWOOD READY BARNS WITH COVERED AISLE

Our standard shelters and barns with plywood ready sides use 12 foot panels that are 7 feet tall that have vertical tubes with tabs welded onto them that the plywood bolts onto with 3/8 inch hardware. (Plywood & mounting hardware not included)

3 sheets of plywood fit recessed inside each bay in the 12 foot wide panel, when they are cut down to 7 feet tall. The panels are made from the same 1-5/8 inch galvanized steel tubing. Barns & shelters are completely modular so you can always add onto them with additional 12x12 stalls or tack / grain / hay rooms.



Plywood READY BARN

Starting at
\$3,700

(Not including Plywood & Hardware)

Wind Anchors

7', 1-5/8" Galvanized
Steel Pole With Clamps
at \$50 each

Paddocks/ Runs

5' Tall x 12' Wide
4 Rail Panel
at \$180 each

Plywood & Mounting Hardware

3 sheets of 5/8 plywood
& mounting hardware,
per 12' wall \$450

2 STALLS

2 Stall, Plywood Ready Barn

- » Stall Size = 12' x 12'
- » Total Cover Area = 12' x 36'
- » Starting at = \$3,700

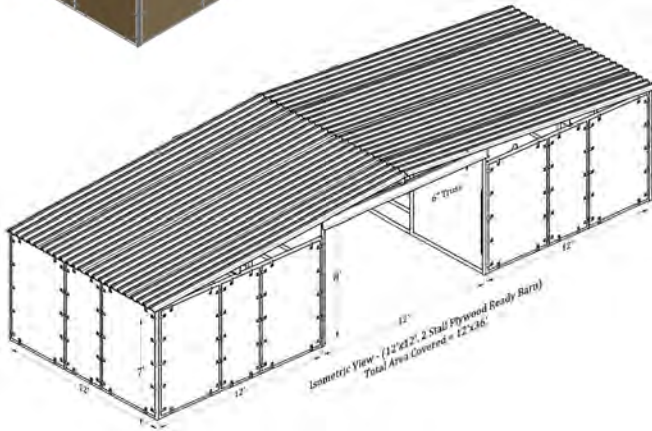
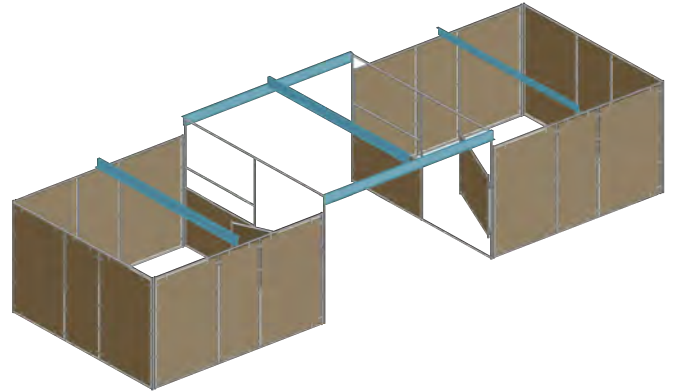
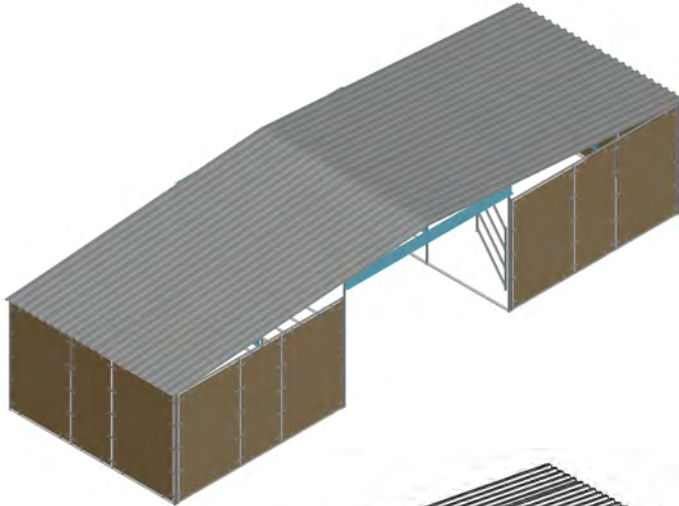

Side View (12'x12', 2 Stall Plywood Ready Barn)

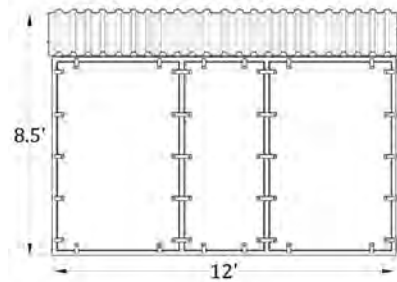

Front Elevation (12'x12', 2 Stall Plywood Ready Barn)

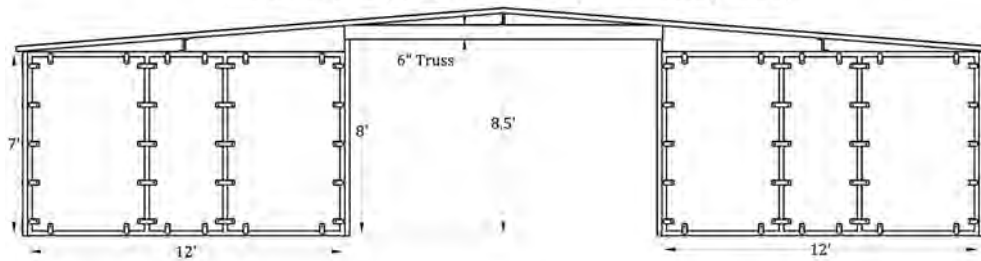

Top View (12'x12', 2 Stall Plywood Ready Barn)
Total Area Covered = 12'x36'

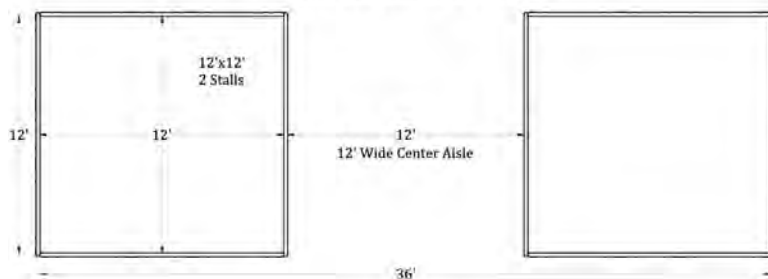

4 STALLS

4 Stall, Plywood Ready Barn

- » Stall Size = 12' x 12'
- » Total Cover Area = 24' x 36'
- » Starting at = \$7,300

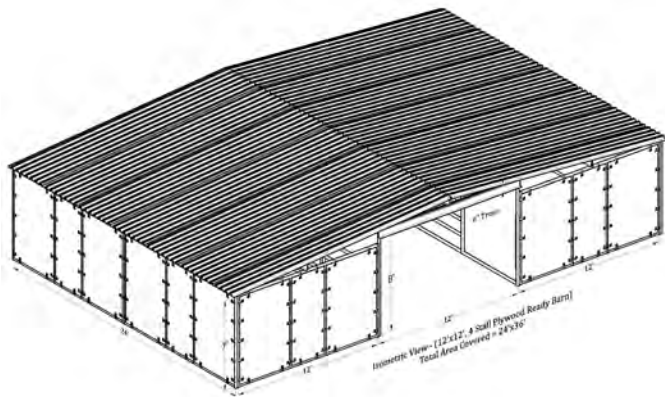
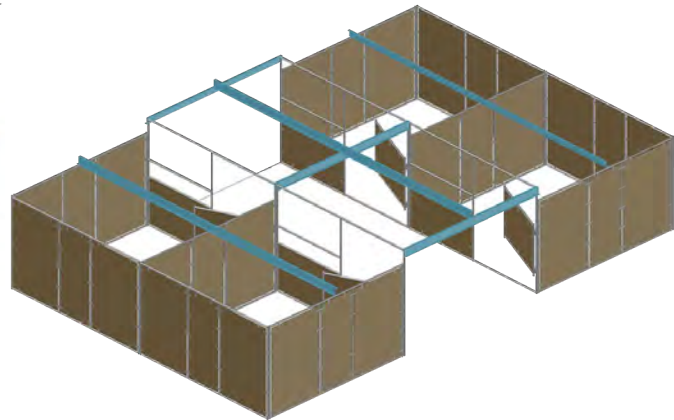
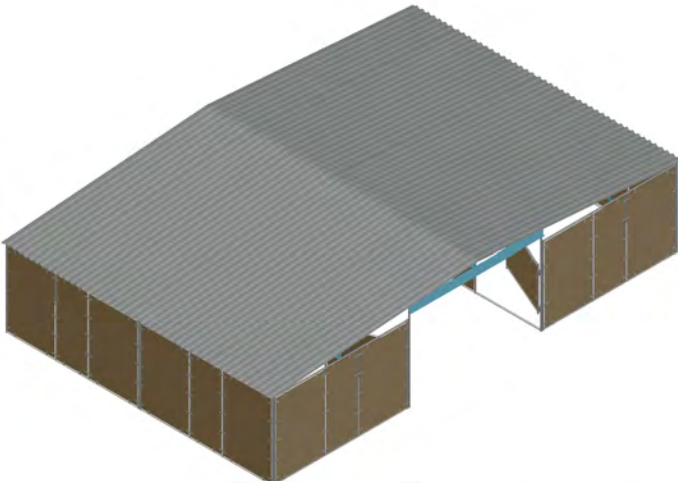

Top View (12'x12', 4 Stall Plywood Ready Barn)
Total Area Covered = 24'x36'

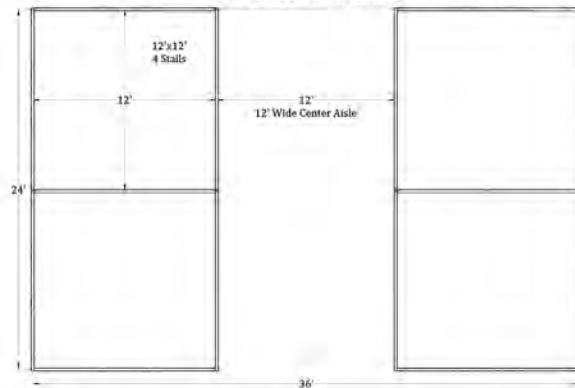

Front Elevation (12'x12', 4 Stall Plywood Ready Barn)

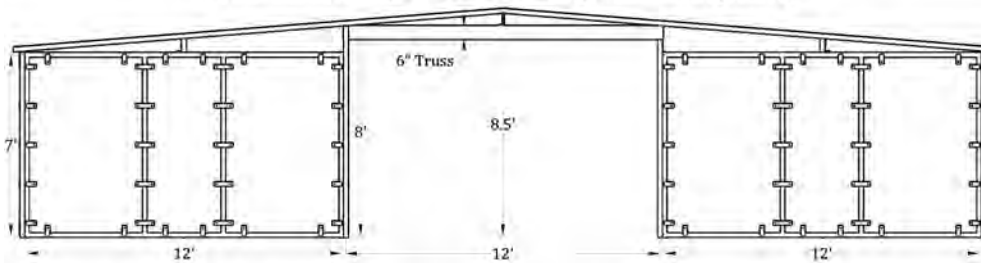

Side View (12'x12', 4 Stall Plywood Ready Barn)

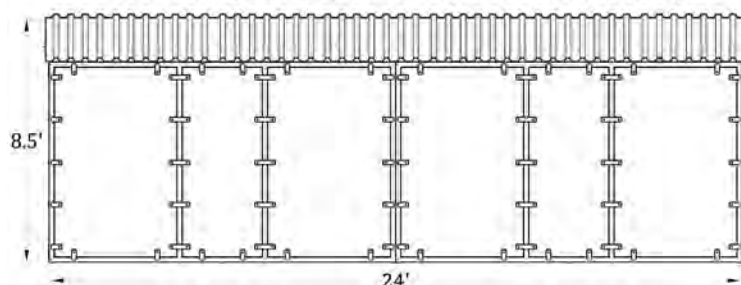

6 STALLS

6 Stall, Plywood Ready Barn

- » Stall Size = 12' x 12'
- » Total Cover Area = 36' x 36'
- » Starting at = \$10,900

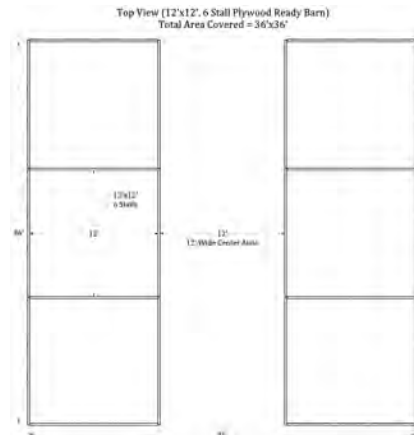
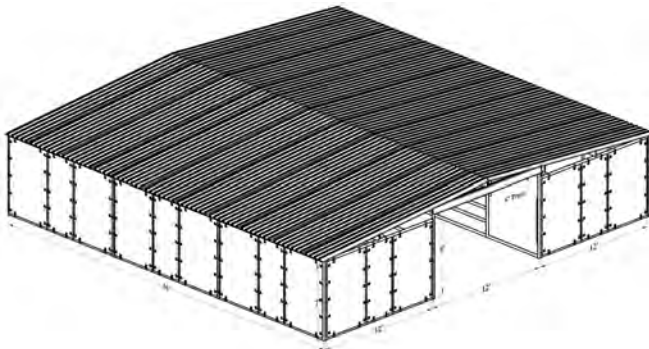
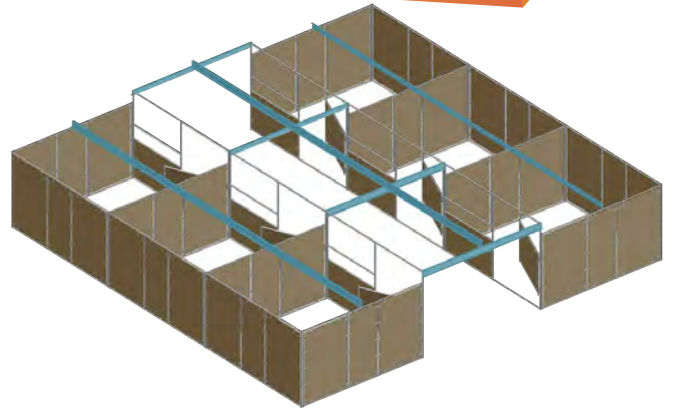
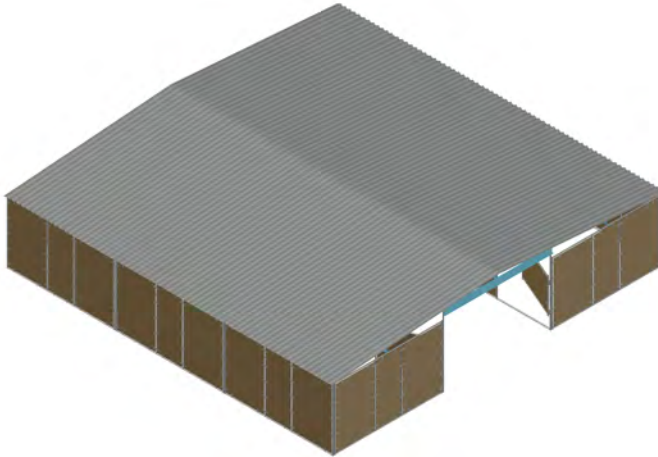

Front Elevation (12'x12', 6 Stall Plywood Ready Barn)

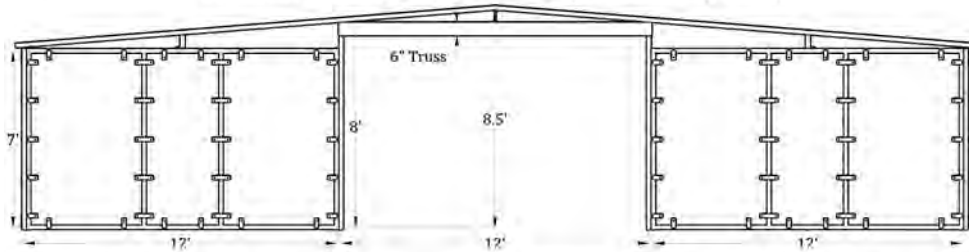

Side View (12'x12', 6 Stall Plywood Ready Barn)

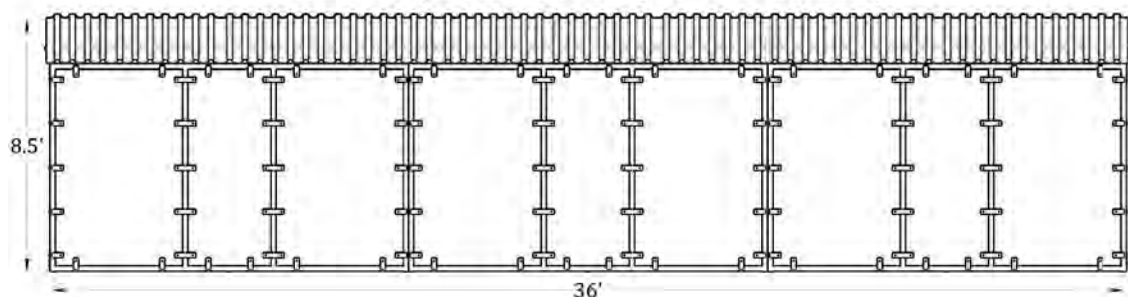

8 STALLS

8 Stall, Plywood Ready Barn

- » Stall Size = 12' x 12'
- » Total Cover Area = 48' x 36'
- » Starting at = \$14,500

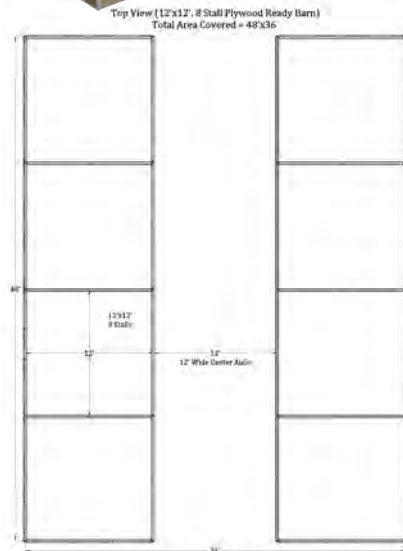
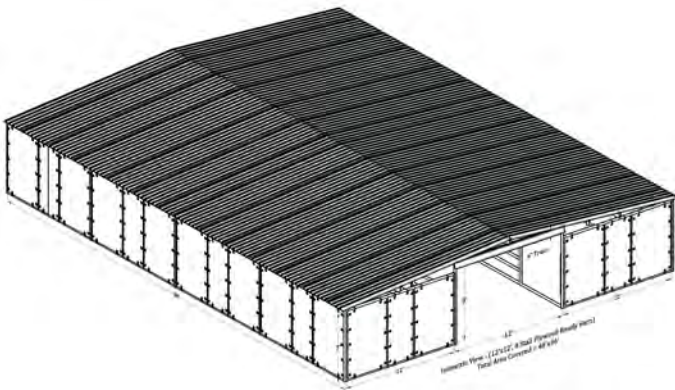
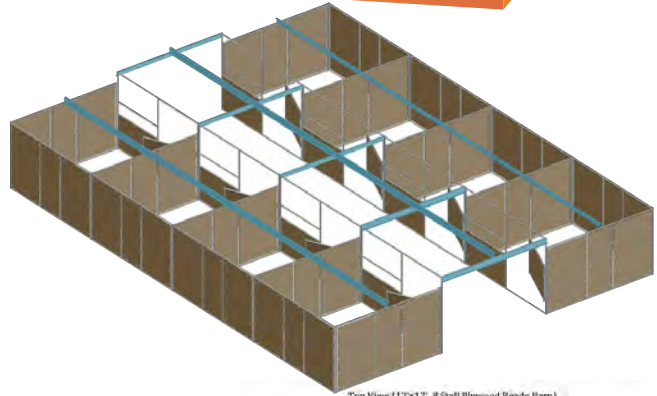
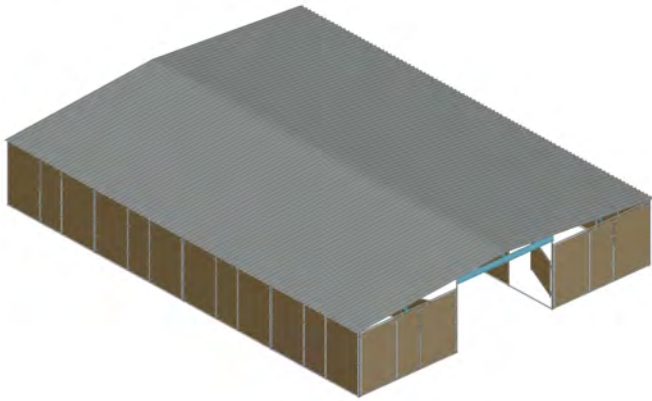

Front Elevation (12'x12', 8 Stall Plywood Ready Barn)

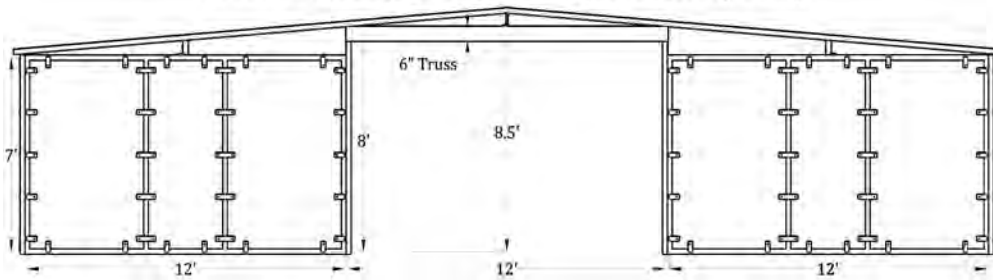

Side View (12'x12', 8 Stall Plywood Ready Barn)

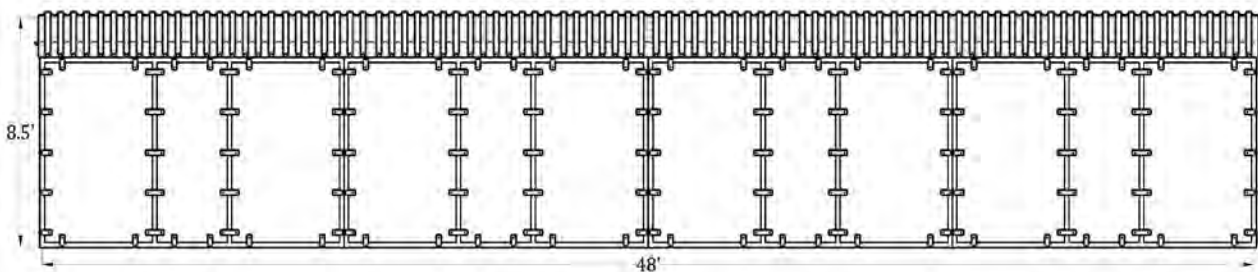

SHELTER OPTIONS

» *Roofing*

» *Plywood Ready Sides*

ROOFING

All roofs have an overhang on the front and back, and you can add optional gutters. The roof panels are all powder coated steel, and include the self-tapping screws with rubber washers to attach to the trusses.

» The 12×13 standard roof has 4, 13 foot PCR roof panels that are screwed directly into the front, middle, and rear trusses of the shelter. **The 12×13 standard roof is what is included in listed prices unless otherwise stated.**

» 14×15 standard roof is just like the 12×13 standard roof, except it uses 5, 15 foot roof panels so you get an overhang on all 4 sides and provides more eaves. This works especially well with the plywood sided shelters to provide maximum coverage from the rain and weather.

» **14x15 roof at \$200 extra per 12x12 shelter.**

» The 12×13 deluxe roof is made from 4, 15 foot PCR roof panels that are screwed into two 12×6 modular roof support panels that clamp to the front and rear truss of the shelter. The two 12×6 modular roof support panels are made from the same 1-5/8" 16 gauge galvanized steel as the rest of the panels that make up the shelter.

» **12x13 deluxe modular roof at \$350 extra per 12x12 shelter.**

PLYWOOD READY SIDES

» Our standard shelters and barns that have plywood ready sides use 12 foot panels that are 7 feet tall having vertical tubes with tabs welded onto them that the plywood bolts onto with 3/8 inch hardware.

» 3 sheets of plywood are cut to fit recessed inside each section in the 12×7 foot panel, that way the horses cant chew on the edges. The panels are made from the same 1-5/8 inch galvanized steel tubing.

» **5/8 plywood & mounting hardware starting at \$450 per 12' wall.**

- » All prices subject to change without notice.
- » All shelters are free standing unless otherwise requested, wind anchors can be provided at an additional charge.
- » Unless otherwise requested, all shelters will be installed as pictured.
- » Prices do not include cost of plywood, each 12' wall requires 3 sheets of plywood & hardware to mount plywood, Fox Barns can provide at additional fee.

Delivery and
complete
set up available,

Contact us
for a
quote